

Cierres para persiana y puerta metálica

Serrures pour rideau métallique roulant et porte métallique
 Fechos para grandes de enrollar e portas metal
 Locks for roller shutter and metallic door

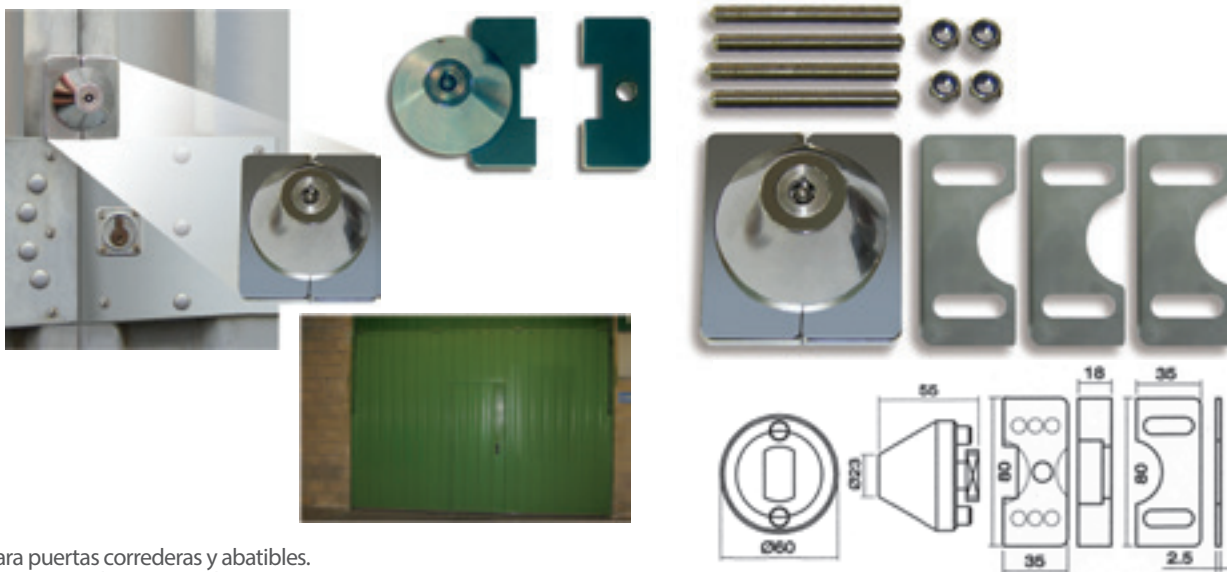

mod: **CBS**



Para puertas correderas y abatibles.
 Pour porte pliante et coulissante.
 Para portas abaivel e de correr.
 For lift and sliding door.

Mod.	Mod. TS	Cod.			BPT pág. 2	MKS pág. 2	Material Matériel
CBS	2	AACS1015	1.459 gr	1	√	√	Cuerpo de latón cromado / Corps de laiton chromé / Corpo de latão cromado / Chrome plated brass body

Modelos válidos para zócalos de chapa y aluminio.
 Modèles valides pour lame d'acier ou d'aluminium.
 Modelos válidos para zócalos de chapa e aluminio.
 Valid models for sheet metal and aluminum sockets.

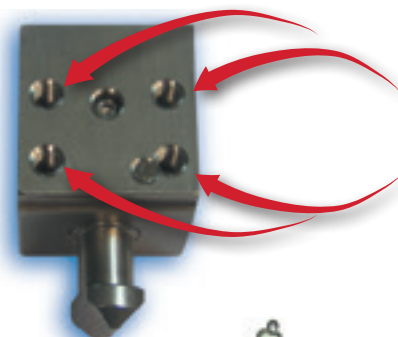

Zócalos aluminio
 Lame finale d'aluminium
 Zócalos aluminio
 Aluminum sockets

Zócalos chapa
 Lame finale d'acier
 Zócalos chapa
 Sockets of metal sheet

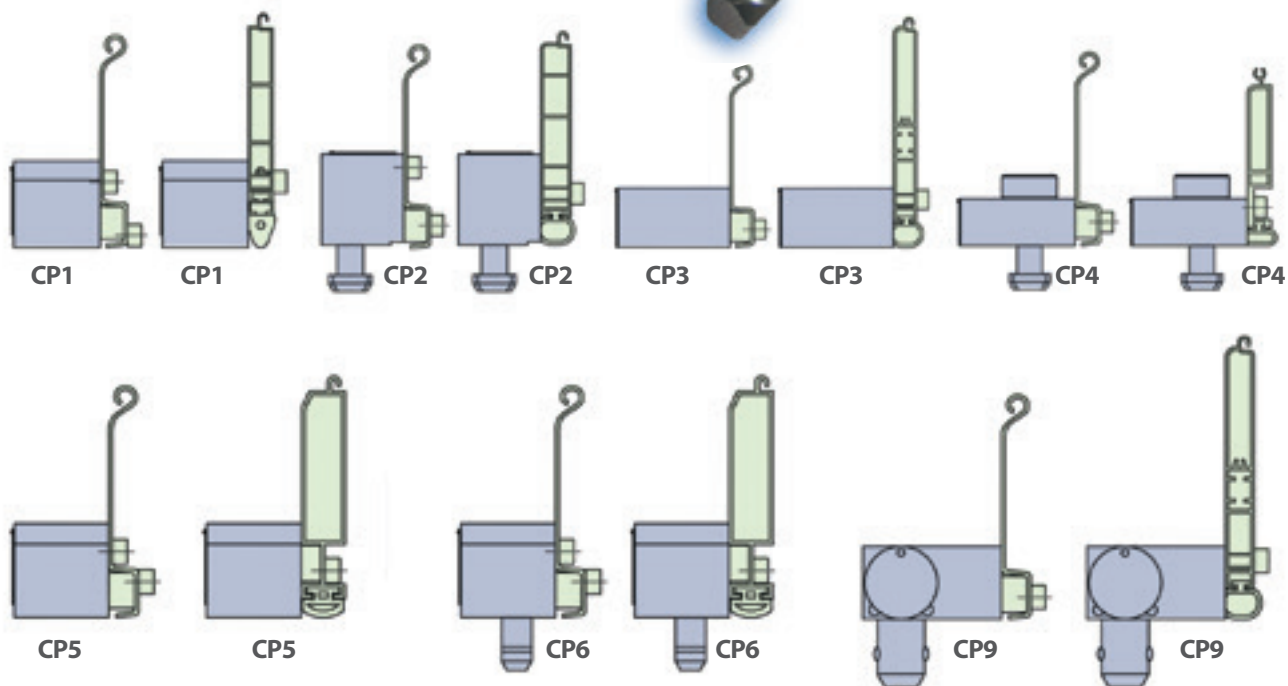

Cierres para persiana y puerta metálica
 Serrures pour rideau métallique roulant et porte métallique
 Fechos para grandes de enrollar e portas metal
 Locks for roller shutter and metallic door

mod: CP1

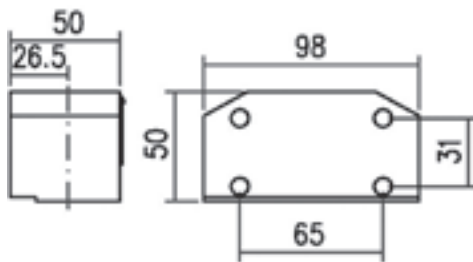

mod: CP2

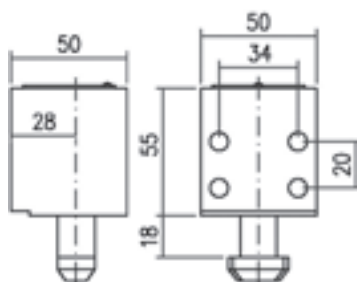

mod: CP3

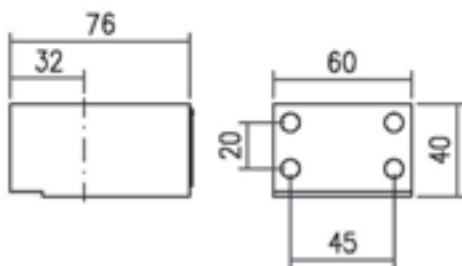

mod: CP4

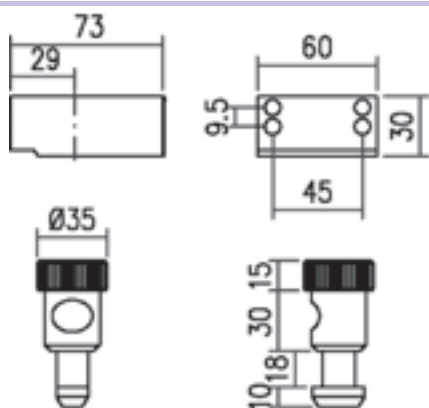

Compatible:
Mod: D-2 (LYF)

Cierres para persiana y puerta metálica
 Serrures pour rideau métallique roulant et porte métallique
 Fechos para grandes de enrollar e portas metal
 Locks for roller shutter and metallic door



Mod.	Mod. TS	Cod.			BPT pág. 2	Material Matériel
CP1	2	AACS0002	2.635 gr	1	√	
Cabezal CP1	2	AACZ0002	1.808 gr	1	√	
CP2	2	AACS0004	1.808 gr	1	√	
Cabezal CP2	2	AACZ0004	1.300 gr	1	√	
CP3	2	AACS0009	2.303 gr	1	√	
Cabezal CP3	2	AACZ0007	1.476 gr	1	√	
CP4	2	AACS0010	1.896 gr	1	√	
Cabezal CP4	2	AACZ0008	1.388 gr	1	√	
CP4	2	AACS0011	1.896 gr	1	√	
Cabezal CP4	2	AACZ0009	1.388 gr	1	√	

Cuerpo de acero inoxidable (AISI 303) / Corps en acier inoxydable (AISI 303) / Corpo em aço inox (AISI 303) / Stainless steel (AISI 303) body
 Cuerpo en acero (F1) cromado / Corps en acier (F1) chromé / Corpo de aço (F1) cromado / Chrome plated steel (F1) body

Cierres para persiana y puerta metálica

Serrures pour rideau métallique roulant et porte métallique
 Fechos para grandes de enrollar e portas metal
 Locks for roller shutter and metallic door



mod: **CP5 · CP5-DB · CP5-IN**

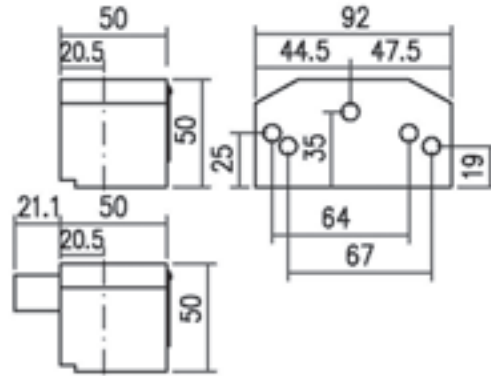
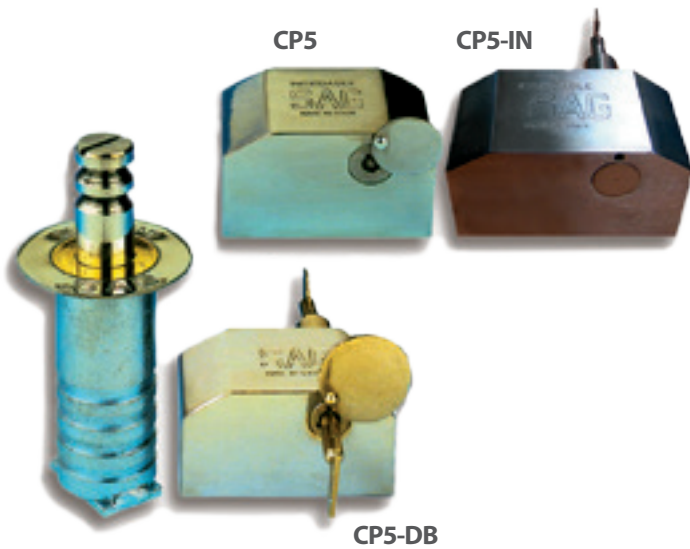

mod: **CP6 · CP6-DB · CP6-IN**



Compatible:
 Mod: T92 (KEYMAT)
 Mod: MVM (AGUILA)

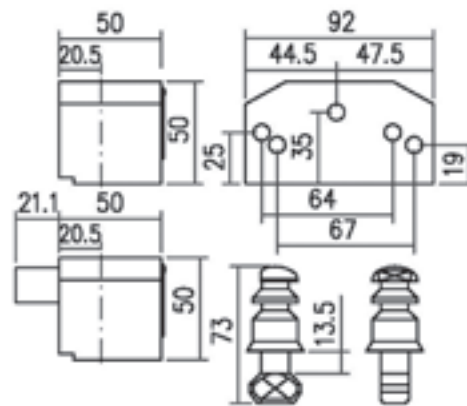

Mod.	Mod. TS	Cod.			BPT pág. 2	Material Matériel
CP5	2	AACS0013	2.510 gr	1	✓	■
Cabezal CP5	2	AACZ0011	1.683 gr	1	✓	■
CP5-DB	2	AACS0015	2.520 gr	1	✓	■
Cabezal CP5-DB	2	AACZ0013	1.693 gr	1	✓	■
CP5-IN	2	AACS0034	2.520 gr	1	✓	■
Cabezal CP5-IN	2	AACZ0035	1.693 gr	1	✓	■
CP6	2	AACS0017	2.349 gr	1	✓	■
Cabezal CP6	2	AACZ0015	1.841 gr	1	✓	■
CP6-DB	2	AACS0019	2.357 gr	1	✓	■
Cabezal CP6-DB	2	AACZ0017	1.849 gr	1	✓	■
CP6-IN	2	AACS0035	2.349 gr	1	✓	■
Cabezal CP6-IN	2	AACZ0034	1.841 gr	1	✓	■

■ Cuerpo de acero inoxidable (AISI 303) / Corps en acier inoxydable (AISI 303) / Corpo em aço inox (AISI 303) / Stainless steel (AISI 303) body

Cierres para persiana y puerta metálica

Serrures pour rideau métallique roulant et porte métallique
 Fechos para grandes de enrollar e portas metal
 Locks for roller shutter and metallic door

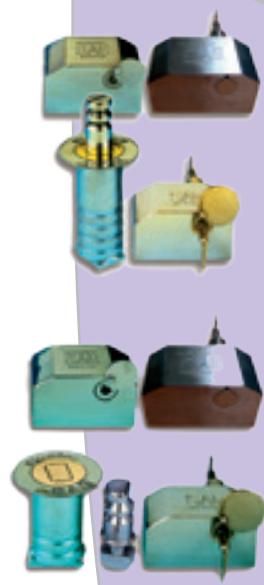

mod: CP7

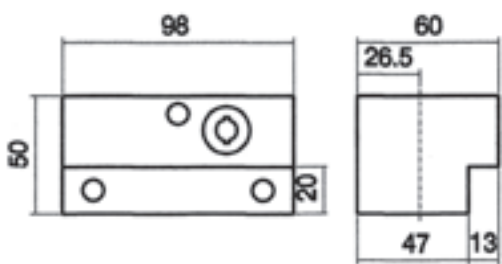

mod: CP8

Compatible:
Mod: C (TOY)

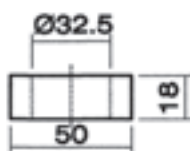
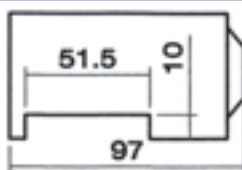
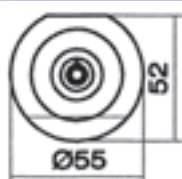

mod: CP9

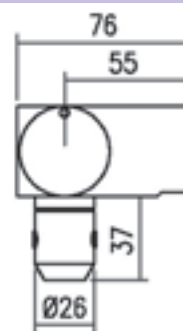
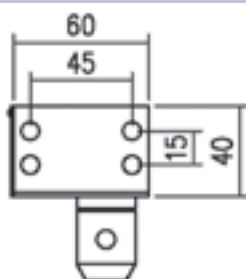

mod: CP12

Compatible:
Mod: K2, K4, K8,
T8, CB40 y CB80
(KEYMAT)

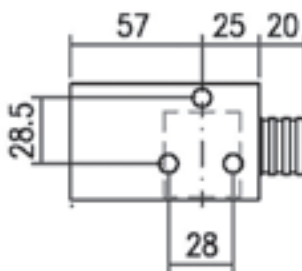

Cierres para persiana y puerta metálica
 Serrures pour rideau métallique roulant et porte métallique
 Fechos para grandes de enrollar e portas metal
 Locks for roller shutter and metallic door



Mod.	Mod.TS	Cod.			BPT pág. 2	MKS pág. 2	Material Matériel
CP7	2	AACS0020	2.850 gr	1	√		
Cabezal CP7	2	AACZ0018	2.013 gr	1	√		
CP8	2	AACS0021	2.876 gr	1	√	√	
Cabezal CP8	2	AACZ0019	2.049 gr	1	√	√	
CP9	2	AACS0024	2.300 gr	1	√		
Cabezal CP9	2	AACZ0022	1.792 gr	1	√		
CP12	2	AACS1027	2.137 gr	1	√		
Cabezal CP12	2	AACZ0037	1.495 gr	1	√		

Cuerpo de acero (F1) cromado / Corps en acier (F1) chromé / Corpo em aço (F1) cromado / Chrome plated steel (F1) body

Cuerpo de latón cromado / Corps en laiton chromé / Corpo de latão cromado / Brass chrome body

Cuerpo de acero inoxidable (AISI 303) / Corps en acier inoxydable (AISI 303) / Corpo em aço inox (AISI 303) / Stainless steel (AISI 303) body

Cierres para persiana y puerta metálica

Serrures pour rideau métallique roulant et porte métallique
 Fechos para grandes de enrollar e portas metal
 Locks for roller shutter and metallic door



mod: **BB1**

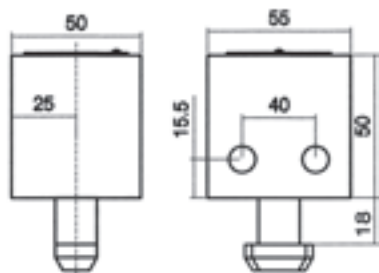

Compatible:
 Mod: D40 (LYF)

mod: **BB2**

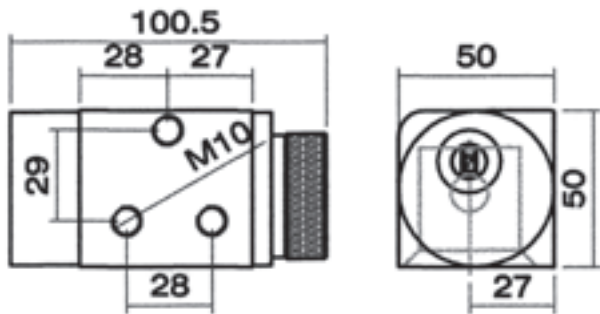

Compatible:
 Mod: K2, K4, K8, T8, CB40
 y CB80 (KEYMAT)

mod: **BB3**

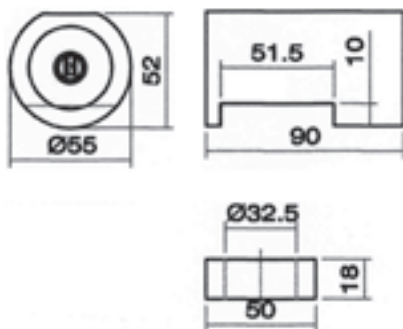

Compatible:
 Mod: C (TOY)

mod: **BB4**

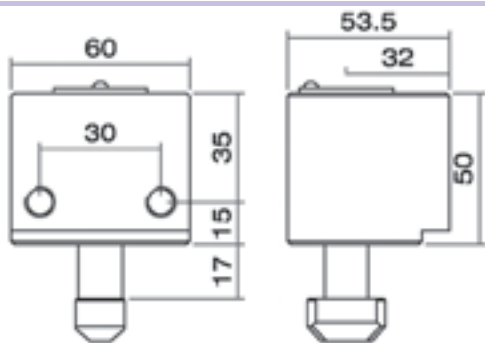

Compatible:
 Mod: D3 (LYF)
 Mod: CE (CAYS)

Cierres para persiana y puerta metálica

Serrures pour rideau métallique roulant et porte métallique

Fechos para grandes de enrollar e portas metal

Locks for roller shutter and metallic door

Mod.	Mod. AGA	Cod.			Material Matériel
BB1	3	AACS1001	1.822 gr	1	
Cabezal BB1	3	AACZ1001	1.285 gr	1	
BB2	3	AACS1009	2.736 gr	1	
Cabezal BB2	3	AACZ1009	1.909 gr	1	
BB3	3	AACS1003	2.762 gr	1	
Cabezal BB3	3	AACZ1002	1.502 gr	1	
BB4	3	AACS1004	1.786 gr	1	
Cabezal BB4	3	AACZ1003	1.278 gr	1	

Cuerpo de acero (F1) cromado / Corps en acier (F1) chromé / Corpo en aço (F1) cromado / Chrome plated steel (F1) body
 Cuerpo de latón cromado / Corps en laiton chromé / Corpo de latão cromado / Brass chrome body



Cierres para persiana y puerta metálica

Serrures pour rideau métallique roulant et porte métallique

Fechos para grandes de enrollar e portas metal

Locks for roller shutter and metallic door

mod: **BB5 • BB5-DB • BB5-IN**

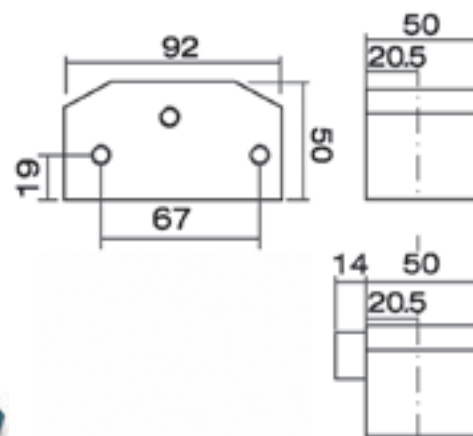

mod: **BB6 • BB6-DB • BB6-IN**



COMPATIBLE:
Mod: T92 (KEYMAT)
Mod: MVM (AGUILA)

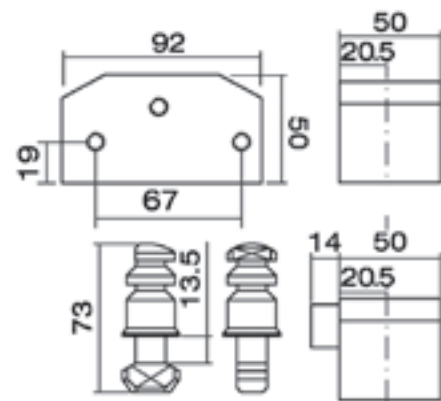

Cierres para persiana y puerta metálica
 Serrures pour rideau métallique roulant et porte métallique
 Fechos para grandes de enrollar e portas metal
 Locks for roller shutter and metallic door



Mod.	Mod. AGA	Cod.			Material Matériel
BB5	3	AACS1005	2.427 gr	1	
Cabezal BB5	3	AACZ1004	1.572 gr	1	
BB5-DB	6	AACS1006	2.474 gr	1	
Cabezal BB5-DB	6	AACZ1005	1.619 gr	1	
BB5-IN	3	AACS0037	2.441 gr	1	
Cabezal BB5-IN	3	AACZ0033	1.590 gr	1	
BB6	3	AACS1007	2.271 gr	1	
Cabezal BB6	3	AACZ1006	1.753 gr	1	
BB6-DB	6	AACS1008	2.319 gr	1	
Cabezal BB6-DB	6	AACZ1007	1.801 gr	1	
BB6-IN	3	AACS0036	2.292 gr	1	
Cabezal BB6-IN	3	AACZ0032	1.772 gr	1	

Cuerpo de acero (F1) cromado / Corps en acier (F1) chromé / Corpo en aço (F1) cromado / Chrome plated steel (F1) body

Cierres para persiana y puerta metálica

Serrures pour rideau métallique roulant et porte métallique
Fechos para grandes de enrollar e portas metal
Locks for roller shutter and metallic door



mod: **BB7**

Compatible:
Mod: 204 (INCECA)

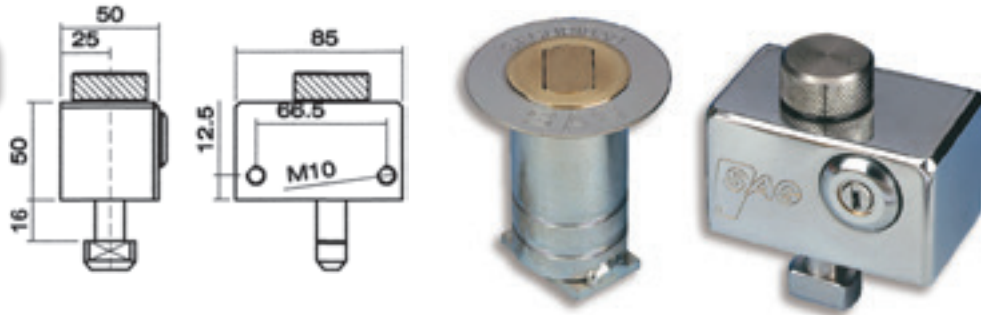

mod: **BB17 · BB8**

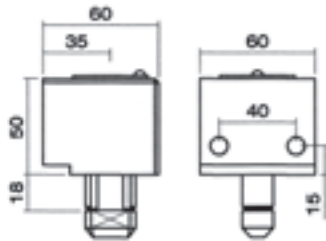

BB17

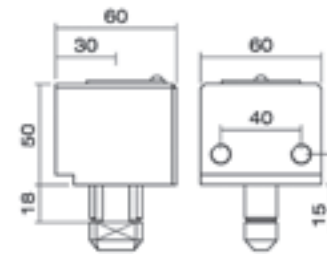

BB8









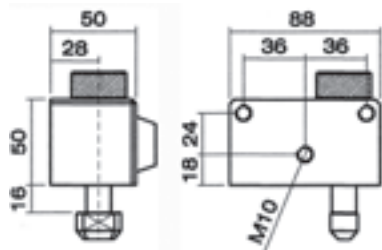

Compatible:
Mod: D3 CUADRADO (LYF)

Compatible:
Mod: ATK05 (STARK)

mod: **BB9**

Compatible:
Mod: GA (TOY)



Mod.	 Mod. AGA	Cod.			Material Matériel
BB7	3	AACS1010	2.528 gr	1	
Cabezal BB7	3	AACZ1008	2.010 gr	1	
BB8	3	AACS1011	2.050 gr	1	
Cabezal BB8	3	AACZ1010	1.652 gr	1	
BB17	3	AACS1026	2.050 gr	1	
Cabezal BB17	3	AACZ1023	1.652 gr	1	
BB9	3	AACS1012	2.528 gr	1	
Cabezal BB9	3	AACZ1011	2.010 gr	1	

 Cuerpo de latón cromado / Coprs en laiton chromé / Corpo de latão cromado / Brass chrome body

Cierres para persiana y puerta metálica
Serrures pour rideau métallique roulant et porte métallique
Fechos para grandes de enrollar e portas metal
Locks for roller shutter and metallic door

mod: BB11

Compatible:
Mod: FRAGAFER

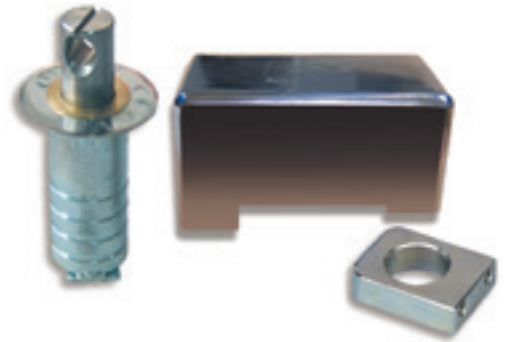
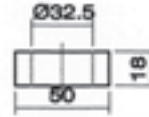
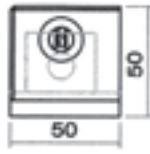

mod: BB12

Compatible:
Mod: K-5 (KEYMAT)

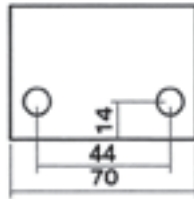

mod: BB13

Compatible:
Mod: K3 (KEYMAT)
Mod: CB-30 (KEYMAT)

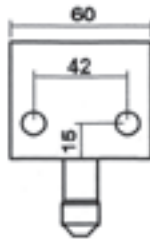

mod: BB14

Compatible:
Mod: ATK02 (STARK)

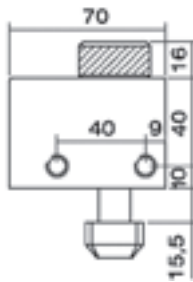

Cierres para persiana y puerta metálica
 Serrures pour rideau métallique roulant et porte métallique
 Fechos para grandes de enrollar e portas metal
 Locks for roller shutter and metallic door



Mod.	Mod. AGA	Cod.			Material Matériel
BB11	3	AACS1018	2.696 gr	1	
Cabezal BB11	3	AACZ1015	1.522 gr	1	
BB12	3	AACS1019	2.062 gr	1	
Cabezal BB12	3	AACZ1016	1.251 gr	1	
BB13	3	AACS1020	1.872 gr	1	
Cabezal BB13	3	AACZ1017	1.310 gr	1	
BB14	3	AACS1022	2.132 gr	1	
Cabezal BB14	3	AACZ1018	1.621 gr	1	

Cuerpo de latón cromado / Coprs en laiton chromé / Corpo de latão cromado / Brass chrome body

Cierres para persiana y puerta metálica

Serrures pour rideau métallique roulant et porte métallique
 Fechos para grandes de enrollar e portas metal
 Locks for roller shutter and metallic door



mod: BB15

Compatible:
 Mod: K10 (KEYMAT)

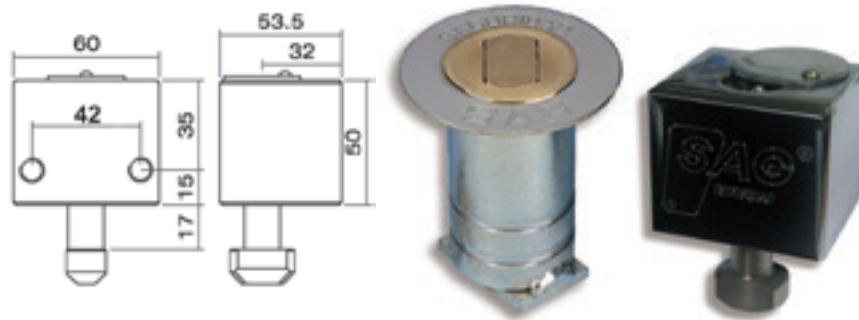

mod: BB16

Compatible:
 Mod: D-1 (LYF)

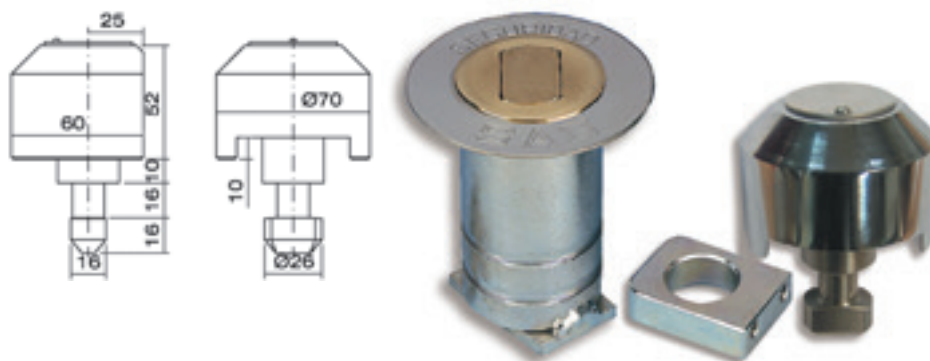

mod: EP1

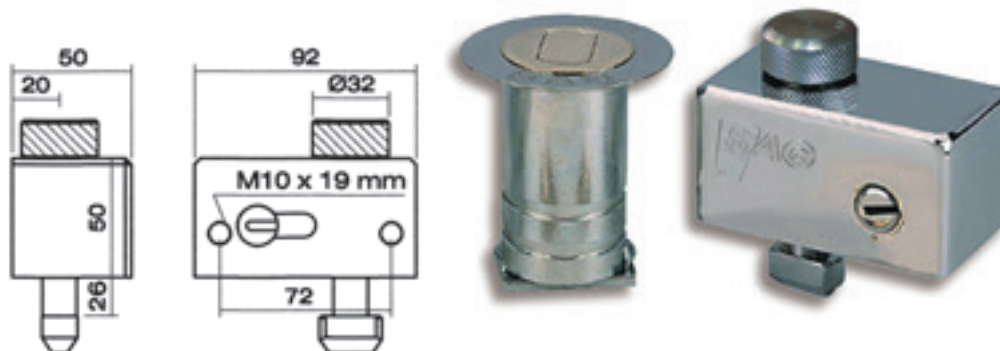

Cierres para persiana y puerta metálica
 Serrures pour rideau métallique roulant et porte métallique
 Fechos para grandes de enrollar e portas metal
 Locks for roller shutter and metallic door

NOT INCLUDED

Mod.	Mod. AGA	Cod.			Material Matériel	
BB15	3	AACS1023	1.905 gr	1		
Cabezal BB15	3	AACZ1019	1.368 gr	1		
BB16	3	AACS1025	2.209 gr	1		
Cabezal BB16	3	AACZ1021	1.415 gr	1		
EP1		AACS0025	2.508 gr	1		✓
Cabezal EP1		AACZ0023	1.971 gr	1		✓

Cuerpo de latón cromado / Coprs en laiton chromé / Corpo de latão cromado / Brass chrome body
 Cuerpo de acero (F1) cromado / Corps en acier (F1) chromé / Corpo en aço (F1) cromado / Chrome plated steel (F1) body

