

Cierres para persiana de ballesta y cancela

Serrures pour grille extensible et porte de grille
 Fechos para portas de batente ou grandes tipo lagarta
 Locks for collapsible and grille gate

mod: **CPT**

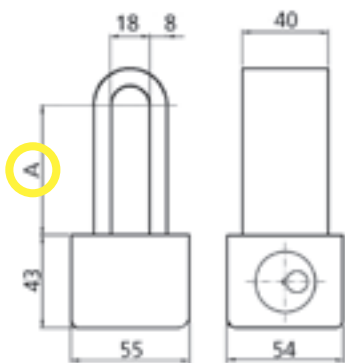

mod: **CPG**

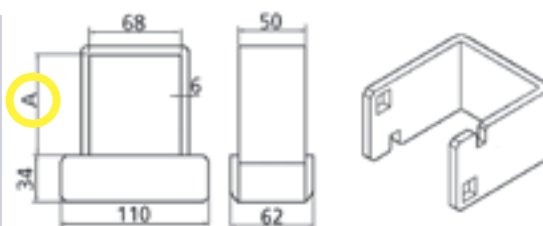



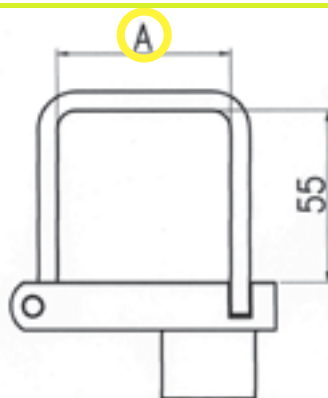















mod: **FCL**



Cierres para persiana de ballesta y cancela

Serrures pour grille extensible et porte de grille
 Fechos para portas de batente ou grandes tipo lagarta
 Locks for collapsible and grille gate

Mod.	Mod. TS	Mod. AGA	Cod.			BPT pág. 2	MKS pág. 2	Material Matériel	 A
CPT 40	2		AACB0006	936 gr	1	✓	✓		40
CPT 50	2		AACB0007	936 gr	1	✓	✓		50
CPT 60	2		AACB0008	936 gr	1	✓	✓		60
CPT 70	2		AACB0021	936 gr	1	✓	✓		70
Juego CPT 40 (2 u.)	2		AACB0009	1.797 gr	1	✓	✓		40
Juego CPT 50 (2 u.)	2		AACB0010	1.797 gr	1	✓	✓		50
Juego CPT 60 (2 u.)	2		AACB0011	1.797 gr	1	✓	✓		60
Juego CPT 70 (2 u.)	2		AACB0022	1.797 gr	1	✓	✓		70
CPG 40	2		AACB0001	1.459 gr	1				40
CPG 50	2		AACB0002	1.512 gr	1				50
CPG 60	2		AACB0003	1.559 gr	1				60
CPG 80	2		AACB0004	1.705 gr	1				80
CPG 100	2		AACB0005	1.794 gr	1				100
FCL 55		3	AACB2001	904 gr	1				55
FCL 75		3	AACB2002	1.049 gr	1				75

 Horquilla de acero inoxidable (AISI 304) / Fourche en acier inoxydable (AISI 304) / Horquilla de aço inox (AISI 304) / Stainless steel (AISI 304) fork

Cierres para persiana de ballesta y cancela

Serrures pour grille extensible et porte de grille
 Fechos para portas de batente ou grandes tipo lagarta
 Locks for collapsible and grille gate



mod: **RCL**

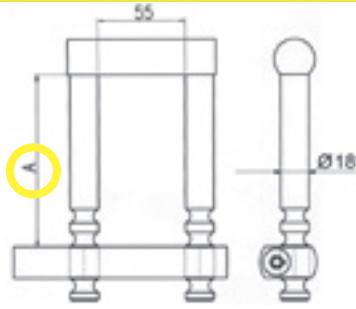

mod: **BAL**

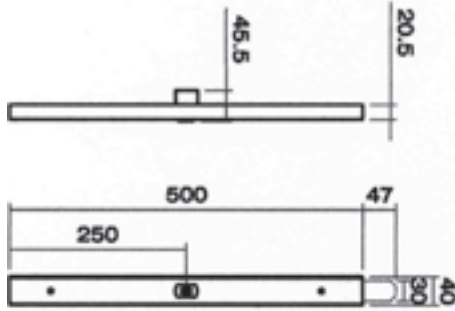

mod: **Juego CY66**

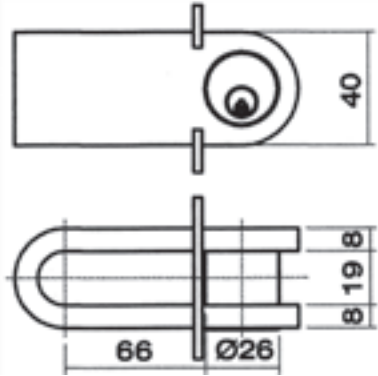

Cierres para persiana de ballesta y cancela

Serrures pour grille extensible et porte de grille
 Fechos para portas de batente ou grandes tipo lagarta
 Locks for collapsible and grille gate

Mod.	Mod. TS	Mod. BS	Cod.	1.432 gr	1	BPT pág. 2	MKS pág. 2	Material Matériel	A
RCL 45-90	2		AACB2003	1.432 gr	1	√	√	■	45-60-75-90
RCL 75-120	2		AACB2004	1.566 gr	1	√	√	■	75-90-105-120
BAL		2	AACB0020	1.514 gr	1			■	
Juego CY66 (2 u.)			6 AACB0019	1.213 gr	1			■	

■ Cuerpo de acero inoxidable (AISI 303) / Corps en acier inoxydable (AISI 303) / Corpo em aço inox (AISI 303) / Stainless steel (AISI 303) body
 ■ Cuerpo de acero (F1) zincado / Corps en acier (F1) zingué / Corpo de aço (F1) zincado / Zinc bath steel (F1)
 ■ Horquilla cromada / Fourche chromé / Horquilla cromado / Chrome plated fork